

Hydrostatic Pump Repair

www.hydrostaticpumprepair.net

Phone: 800-361-0028

Email: sales@hydrostatic-transmission.com



HMF/V/R-02



**High-Pressure Motors
for Open and Closed
Loop Circuits**



Becoming a World Market Leader with Linde Hydraulics

Linde – **the pioneer in mobile hydraulics** – discovered and perfected hydrostatics as the ideal drive for mobile working machines. Since 1959, Linde has equipped two million vehicles in the fields of

- Construction machinery
- Agricultural and forestry machinery
- Municipal vehicles
- Fork lift trucks

with hydrostatic transmissions and working drives. The use of hydrostatic transmissions in its own fork lift trucks has made Linde the **world market leader!**

HMF/WR-02

CONTENTS	Page
1. Features and technical data	2
2. HMF-02 fixed displacement motors	4
3. HMF-02 variable displacement motors	
3.1 <i>Two-position control (flip/flop)</i>	5
3.2 <i>Infinitely variable control</i>	6
3.3 <i>Infinitely variable control with pressure override</i>	7
4. HMR-02 pressure regulating motors	8
5. Design Configurations	
5.1 <i>High-pressure porting</i>	9
5.2 <i>Mountings</i>	9
6. Control Options	
6.1 <i>Displacement control</i>	10
6.2 <i>Displacement override</i>	10
6.3 <i>Servo supply pressure feed</i>	11
6.4 <i>Purge and case flushing</i>	11
6.5 <i>Crossover relief protection</i>	12
6.6 <i>Brake pressure shut off</i>	12
6.7 <i>Counterbalance valve</i>	13
6.8 <i>Speed sensor</i>	13
7. Model codes	14
8. General dimensions	17
9. Special motors	19
10. Pressure fluids and filtration	20
11. Areas of application	21

1. FEATURES AND TECHNICAL DATA



Features

- Axial piston swash plate, motor with these general advantages:
 - High degree of conformability
 - High rate of angular acceleration
 - High starting torque efficiency
- Compact design with high power density
- Superior quality
- Optimized for:
 - High reliability
 - Long working life
 - Low noise emission
 - High efficiency

Design Characteristics

- Swash plate angle 21°
- Increased working life as a result of special hydraulic cradle bearings and a unique slipper/piston swedge connection
- Optimized power flow as a result of swash plate design
- User friendly to fit a wide variety of applications as a result of
 - Modular design for easy conversion

Nominal Sizes

- 28, 35, 55*, 75, 105, 135
- 165 and 210 under development

* (Fixed Motor = 50cc)

**The data on which this brochure is based correspond to the current state of development.
We reserve the right to make changes. The dimensions and technical data
of the individual installation drawings are binding.**

Technical Data

Nominal Sizes		28	35	55 *8)	75	105	135	165	210	
Displacement	Maximum [cm ³ /rev]	28.6	35.6	54.8	75.9	105.0	135.6	Under Development		
	Minimum *1) [cm ³ /rev]	−*7)	−*7)	18.3	25.3	35.0	45.2			
Speed	Max. operating speed (at 100% duty cycle) at maximum displacement [rpm]	4500	4500	4100	3800	3500	3200			
	Highest speed (intermittent) at maximum displacement [rpm]	4800	4800	4400	4100	3800	3500			
	Max. operating speed (at 100% duty cycle) at minimum displacement [rpm]	−*7)	−*7)	4700	4400	4100	3700			
	Highest speed (intermittent) at minimum displacement [rpm]	−*7)	−*7)	5300	5000	4700	4000			
Pressure	Continuous pressure (delta p) [bar]	250								
	Max. operating pressure [bar]	420								
	Highest pressure (intermittent) [bar]	500								
	Permissible case pressure (absolute) [bar]	2.5								
Torque	Continuous output torque *2) [Nm]	114	142	218	302	418	540			
	Max. output torque *3) [Nm]	191	238	366	508	702	907			
Power	Continuous power *4) [kW]	54	67	94	120	153	181			
	Max. power *5) [kW]	90	112	157	202	257	304			
Per. Shaft Loads	Axial input force [N]	2000								
	Axial output force [N]	2000								
	Radial [N]	on request								
Per. Housing Temperature	[°C]	90								
Weights	Fixed displacement motor *6) [kg]	16	16	19	26	33	39			
	Variable displacement and pressure regulating motor *6) [kg]	−*7)	−*7)	28	32	42	56			
	Moment of inertia [kgm ² x10 ⁻²]	0.25	0.25	0.49	0.79	1.44	2.15			
Main Dimensions		see Section 8								

- * 1) For variable displacement and pressure regulating motors only
- * 2) At continuous pressure
- * 3) At maximum operating pressure
- * 4) At maximum operating speed, maximum displacement and continuous pressure

- * 5) At maximum operating speed, maximum displacement and maximum operating pressure
- * 6) Applies to standard SAE mount versions (see Section 5.2)
- * 7) Version is under development
- * 8) Fixed displacement motor is 51.3 cm³/rev; as a result there will be corresponding different values for torques and power

2. HMF-02 FIXED DISPLACEMENT MOTORS

Fixed displacement motors of the HMF-02 type are suitable for both open and closed loop circuit



Fixed displacement motor (standard version)



Details: (top picture) Fully adjustable pilot operating crossover relief valves. (lower picture) Dual pressure pilot operated crossover relief valves.

Two porting options and a variety of equipment options are available for this motor (see Section 5 and 6) to ensure the best possible adaptation to your specific application.

The use of dual pressure crossover relief valves broadens the spectrum of possible applications. The low setting of the relief valve permits soft gentle braking of the motor. When the relief valve is triggered to its high setting, maximum acceleration and braking torque is available at the motor. A typical application of this type is a turning and boring mill drive.

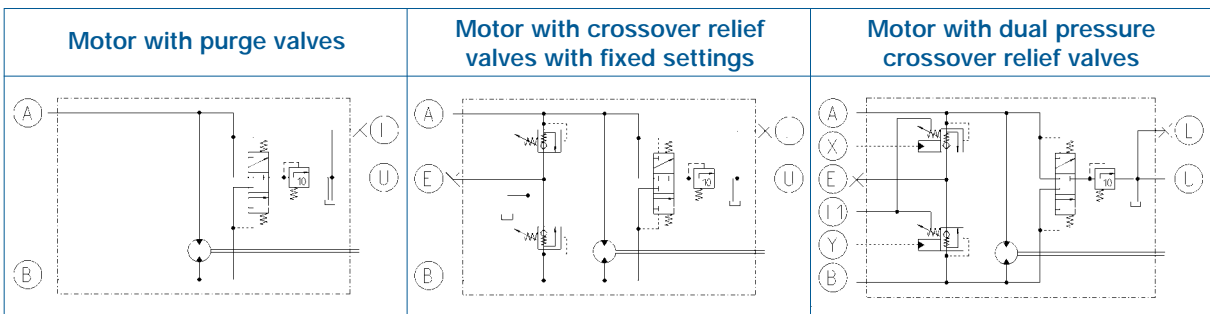
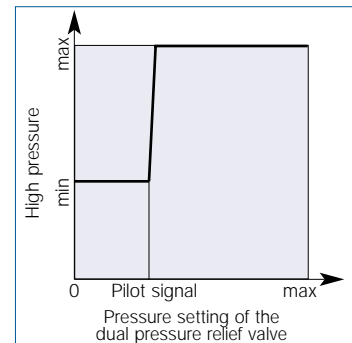

A, B Working port connections
L, L1, U Case drain, vent connections

E Anti-cav connection
X, Y Control connections for dual pressure crossover relief valve

3. HMV-02 TWO-POSITION MOTORS

3.1 Two-position control (flip-flop)



Two-position motor with electric control

Two position motors are suitable for both open and closed loop circuits. They are at maximum flow displacement (V_{max}) with no control signal and make a smooth transition to minimum displacement when a control signal is applied.

The control can either be:

- **hydraulic** shifted with pilot pressure
- **electric** shifted with a direct current electric signal

Servo supply pressure can be provided externally or internally, depending on the motor's design configuration (see Section 6.3)

Technical Data

Rating				The values listed below are applicable for all nominal sizes		
Adjustable Pressure Supply *1)	externally supplied at port (E)	minimum	[bar]	20		
		maximum permissible	[bar]	40		
Hydraulic Control Signal *2)	Pressure at port (X) to shift	minimum	[bar]	20		
		maximum permissible	[bar]	40		
Electric *2) Control Signal	Connector type *3)			Hirschmann		
	Voltage (=continuous limit voltage)			[V]	12	24
	Voltage type			Direct current		
	Power consumption (cold power)			[W]	≤ 26	
	Relative duty cycle			[%]	100	
	Protection class			IP 6K6K, Part 9		
Response Time		minimum *4)	[sec]	0.5		

*1) connection E in the circuit diagram shown below
 *2) connection X in the circuit diagram shown below

*3) other connector versions on request
 *4) other response times are possible by using special nozzles

Circuit Diagram and Adjustment Characteristics

- A, B Work ports connection
- L, U Case drain/vent connections
- E Servo supply pressure connection
- X Control connection

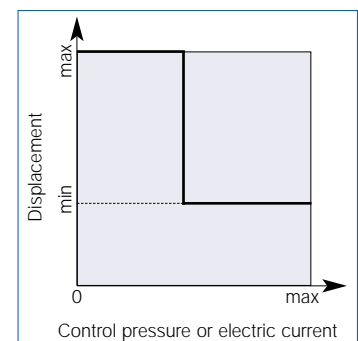
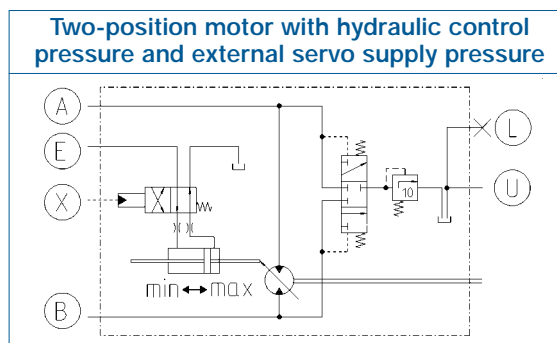

3.2 HMV-02 Infinitely Variable Control



Infinitely variable motor with hydraulic displacement control

Motors with infinitely variable displacement control are suitable for both open and closed loop circuits. They are at maximum displacement (V_{max}) with no control signal and shift proportionally to minimum displacement with a proportional control signal.

The control signal can be either:

- **hydraulic** using a proportional control pressure, or
- **electric** applying variable direct current to a proportional solenoid.

Servo supply pressure can be provided externally or internally, depending on the motor's design configuration (see Section 6.3).

Technical Data

Rating			The values listed below are applicable for all rated sizes		
Ext. servo supply pressure *1)	minimal	[bar]	20		
	maximum permissible	[bar]	40		
Hydraulic control signals	Control range	[bar]	8 to 14		
	maximum permissible pressure	[bar]	40		
Electric control signals *2)	Connector type *3)		Hirschmann		
	Nominal voltage (=continuous limit voltage) [V]		12	24	
	Voltage type		Direct current		
	Power consumption [W]		15.6		
	Nominal current (=continuous limit current) [mA]		1300		
	Control current	Swash begin	[mA]	450	225
		Swash end	[mA]	1200	600
	Relative duty cycle		100		
Protection class		IP 6K6K, Part 9			
Response time	minimum *4)	[sec]	0.5		

*1) connection E in the circuit diagram shown below

*2) connection Mx in the circuit diagram shown below

*3) other connector versions on request

*4) other response times are possible by using special orifices

Circuit Diagram and Adjustment Characteristics

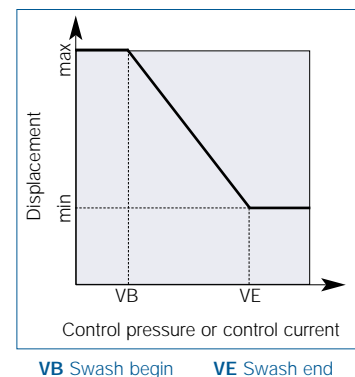
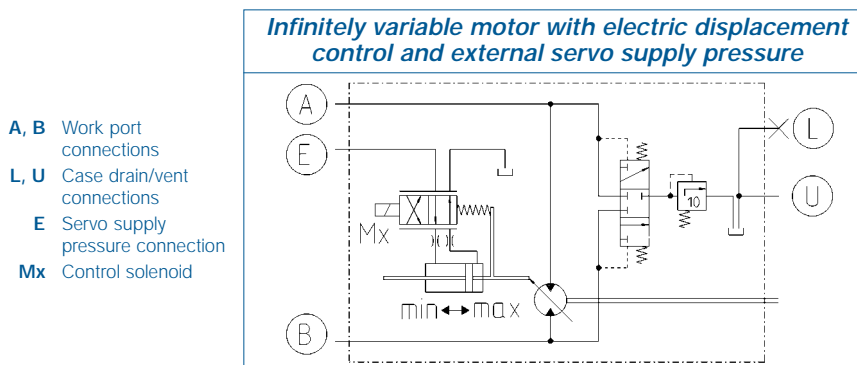

3.3 HMV-02 Infinitely Variable Control with Pressure Override



Variable motor with pressure override

This motor is used primarily in closed loop circuits.

It is at maximum displacement (V_{max}) with no control signal. Variable displacement control to lower displacement is accomplished hydraulically with the application of a proportional control pressure signal by the operator.

The motor is also equipped with a system pressure override (POR) which increases the motor's displacement in response to system-related demands for torque when a predefined system pressure setting is reached, overriding the operator's command for lower displacement.

In addition, this motor has

- electric maximum displacement override (DOR) that makes it possible to shift the motor to its maximum displacement independently of the control pressure, and to lock it there, (as with the fixed displacement motor.
- electric brake pressure shut off (BPS). It prevents abrupt reactions and response by the system pressure override control to dynamic braking pressures, and thus makes it possible for a more controlled deceleration of the vehicle.

Technical Data

Rating			The values listed below are applicable for all rated sizes
Hydraulic control signal *1)	Control range	[bar]	8 to 14
	Maximum permissible pressure	[bar]	40
Hydraulic pressure override	Start of pressure RB *2)	[bar]	190 - 260
	End of pressure RE	[bar]	5% above start of pressure
Switching magnet	All electrical data *4)		See table on page 5
Response time	Minimum *3)	[sec]	0.5

*1) connection X in the circuit diagram shown below

*3) other response times are possible by using special orifices

*2) adjustable, please indicate when ordering (see Section 7.3)

*4) other control options are available to control DOR and BPS. (see Section 6.2, page 10)

Circuit Diagram and Adjustment/Control Characteristics

Infinitely variable displacement control motor with pressure override, electric maximum displacement override, and brake pressure shut off.

- A, B** Working port
- L, U** Case drain/vent connections
- X** Pressure connection for infinitely variable control
- M1** Solenoid for maximum displacement override
- M2** Solenoid for brake pressure shut off

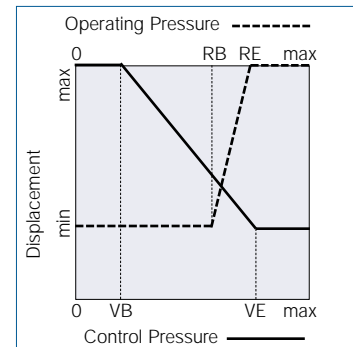
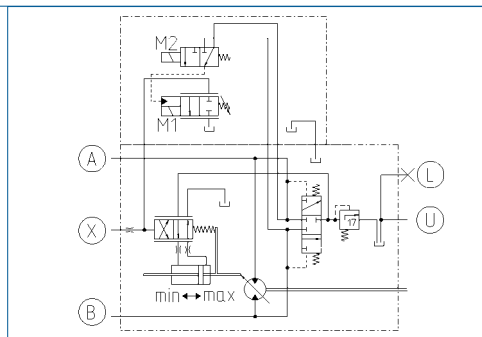

VB Swash begin
VE Swash end

RB Start of pressure override
RE End of pressure override

4. HMR-02 Pressure Regulating Motors



Pressure regulating motor with electric maximum displacement override and cross over relief valve protection



Pressure regulating motor with electric maximum displacement override and brake pressure shut off.

Linde pressure regulating motors are suitable for both open and closed loop circuits. They are high-pressure controlled, and are at minimum displacement (V_{min}) when system pressure is below the pressure regulation set point of regulation begin (RB). When the pressure regulation set point is reached, the motor smoothly increases displacement in response to system-dependent demands for torque. The additional maximum displacement override control makes it possible to shift the motor to maximum displacement independently of the pressure regulating control, and locks it there as with a fixed displacement motor.

The maximum displacement override signal can be either:

- **pneumatic** shifted with a low pressure air signal
- **hydraulic** shift with a hydraulic pressure signal
- **electric** shift with a direct current electric signal.

The typical configuration of pressure regulating motors for use in open or closed loop circuits is as follows:

- Open loop circuit: with cross over relief valve protection and counter balance valve (see Section 6.7)
- Closed loop circuit: with electric brake pressure shut off (see Section 6.6)

Technical Data

Rating			The values listed below are applicable for all nominal sizes
Pressure regulating control	Regulation begin (RB) *1)	[bar]	190 to 260
	Regulation end (RE)	[bar]	5% above regulation begin (RB)
Pneumatic max. displ. override	Shifting pressure min/max	[bar]	4 to 8
Hydraulic pilot pressure max. displ. override	Shifting pressure min/max	[bar]	20 to 30
Hydraulic high-pressure max. displ. override	Shifting pressure min/max	[bar]	30 to 420
Electric max. displ. override	All electrical data		See table page 5
Electric brake pressure shut off *2)			

*1) adjustable, please indicate when ordering (see Section 7.4)

*2) other options are available for brake pressure shut off. (see Section 6.2)

Circuit Diagram and Control Characteristics

- A, B Works port connections
- L, U Case drain/vent connections
- M1 Solenoid for maximum displacement override regulation
- X, Y Gauge ports

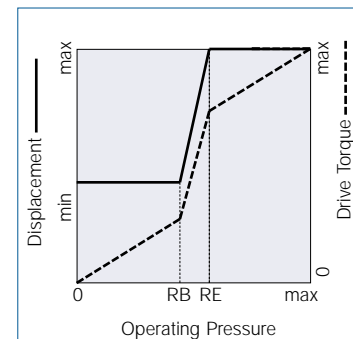
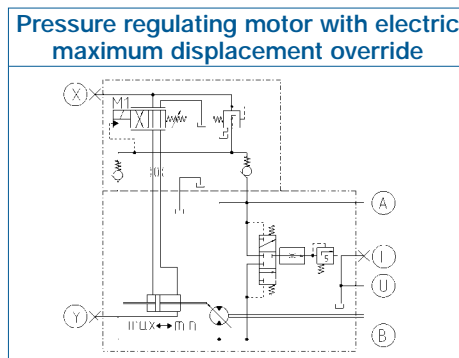



RB Regulation Begin RE Regulation End

5. DESIGN CONFIGURATIONS

Depending on the installation situation and accessibility, optional rear or side high-pressure ports are available. SAE flange mounts or plug in style are

also available. The following tables show the suitability and availability.

5.1 Arrangement of the High-Pressure Ports



Suitability and availability for motor types		Fixed displ. motor		Variable displ. motor		Var displ. motor + override control	Pressure regulating motor	
		open	closed	open	closed		open	closed
	Picture	Circuit loop						
Side		✓	✓	✓	✓	✓	✓	✓
Rear *1)		✓	✓	✓	✓	✓	✓	✓

*1) selected sizes available

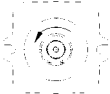
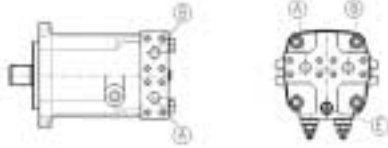
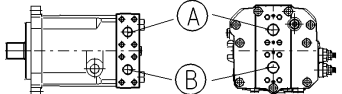
Input Flow vs. Shaft Output Rotation

Identification of Ports		Shaft Output Direction of Rotation	
			
	Motor Type	Input Flow Into Port	
	HMF-02	A	B
	HMR-02	B	A
	HMV-02	B	A

5.2 Mounting Versions

Suitability and availability for motor types		Fixed displ. motor		Variable displ. motor		Var displ. motor + override control	Pressure regulating motor	
		open	closed	open	closed		open	closed
	Picture	Circuit loop						
SAE flange *1)		✓	✓	✓	✓	✓	✓	✓
Plug-in *1) *2)	presently reversed left to right 			✓	✓	✓	✓	✓

*1) see Section 8.5 for dimensions

*2) selected sizes available (see Section 8.5)

6. CONTROL OPTIONS

Linde motors can be optimally adapted to the widest possible variety of applications and prevailing conditions by means of a wide range of control

options. The tables show the specific suitability and availability.

6.1 Displacement Control

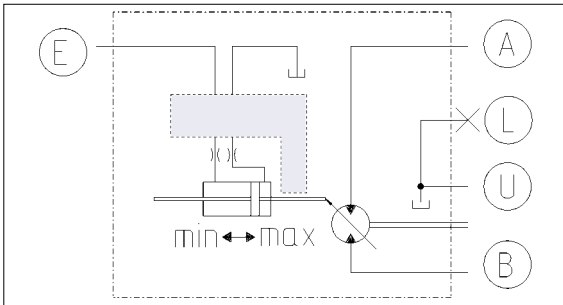

Control of variable displacement motors is achieved by varying the position of the motor's swash plate. (see Section 3 for functional descriptions.) Swash controls shown are available in various options for servo supply pressure feed (see Section 6.3).

Suitability and availability for motor types		Fixed displ. motor	Variable displ. motor		Var. displ. motor + override control	Pressure regulating motor	
	Circuit diagram		open	closed	closed		
Hydraulic two position			✓	✓	-		
Electric two position			✓	✓	-		
Hydraulic proportional			✓	✓	✓		
Electrical proportional 12 v or 24 V			✓	✓	-		

6.2 Displacement Override (DOR)

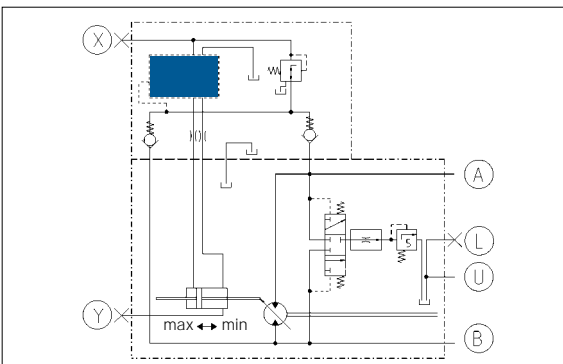

Linde pressure regulating motors are system-pressure controlled, consequently, the swash plate control pressure is supplied internally via the high-pressure circuit. Pressure regulating motors have a Vmax maximum displacement override circuit (see Section 4 for a functional description). Available maximum displacement override are listed below.

Suitability and availability for motor types		Fixed displ. motor	Variable displ. motor	Var. displ. motor + override control	Pressure regulating motor	
	Circuit diagram			closed	open	closed
DOR circuit						
Pneumatic				-	✓	✓
Hydraulic pilot pressure				-	✓	✓
Hydraulic high pressure				-	✓	✓
Electric 12 V or 24 V				✓	✓	✓

6.3 Servo Supply Pressure Feed

Servo supply pressure delivers the force needed to change the position of the swash plate in variable displacement and pressure regulating motors.

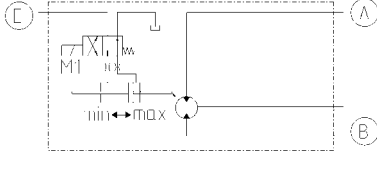
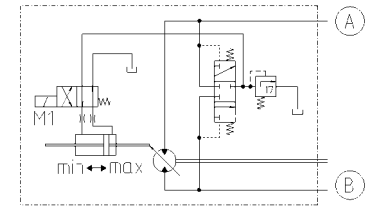
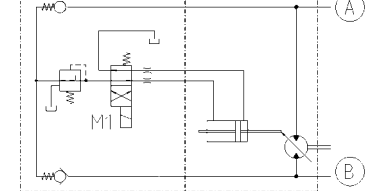
Suitability and availability for motor types		Circuit diagram	Circuit loop	Fixed displ. motor		Variable displ. motor		Var. displ. motor + override control	Pressure regulating motor	
				open	closed	open	closed	closed	open	closed
External supply				-	✓ ^{*1)}	-	-	-	-	-
Internal supply from the purge circuit				-	✓	-	✓	-	-	-
Internal supply from the high-pressure circuit				✓ ^{*2)}	-	-	-	✓	✓	✓

*1) standard configuration for variable closed loop motors

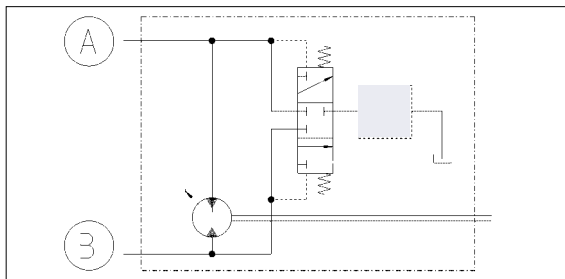

*2) special two-position motor

6.4 Purge and Case Flushing

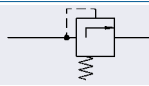
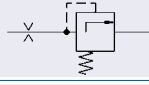

Purge and case flushing circuitry is used:

- for reducing the temperature of the motor and the system in the open and closed loop circuits
- for replacing the oil in the circuit
- to enhance filtration, and
- for removing air from the system

Suitability and availability for motor types			Fixed displ. motor		Variable displ. motor		Var. displ. motor + override control	Pressure regulating motor	
Purge valve types	Flow [l/min]	Schematic symbol	open	closed	open	closed	closed	open	closed
None	0	-	✓ ^{*6)}	- ^{*4)}	✓ ^{*6)}	- ^{*4)}	-	✓ ^{*6)}	- ^{*4)}
Standard Relief	10 ^{*1)}		-	✓ ^{*5)}	-	✓ ^{*5)}	✓ ^{*2)}	-	✓ ^{*5)}
Orificed relief	5 ^{*1)}		-	✓	-	✓	-	-	✓
Flow controlled	4 ^{*3)}		✓	- ^{*4)}	✓	- ^{*4)}	-	✓	- ^{*4)}

*1) at 16 bar feed pressure and 10 bar purge relief valve

*2) at 20 bar feed pressure and 14 bar purge relief valve

*3) at 5 bar pressure control valve; independent of low pressure

*4) suitability under certain conditions on request

*5) standard version for motors in closed loop circuit

*6) these motors are normally equipped with cross over relief valves instead of purge valves

6.5 Cross Over Relief Protection

HMF/HMV/HMR-02 motors are available with integrated cross over relief valves to protect the system against pressure overloads. Relief valves are pilot operated reliefs in combination with anti-cavitation checks. The use of these relief valves is recommended whenever pressure limiting control has not been provided in some other way (e.g. by means of primary pressure relief or pressure cut off at the pump or LSC valves).

Anti-cavitation is facilitated through connection E, shown in the circuit diagrams. This may be needed in open loop circuits if the motor requires more oil than can be supplied to it, especially in dynamic braking situations. For special installations (e.g. for turning and boring mill drive), the use of dual pressure cross over relief valves should be considered. (see Section 2)

Suitability and availability for motor types		Fixed displ. motor		Variable displ. motor		Var. displ. motor + override control	Pressure regulating motor	
	Circuit diagram	open	closed	open	closed	closed	open	closed
Without crossover relief valve		✓	✓	✓	✓	✓	✓	✓
With crossover relief valve protection *1)		✓ *1)	✓ *1)	-	-	-	✓	✓
With dual pressure relief valve protection *2)		✓ *1)	-	-	-	-	-	-

*1) availability on request

*2) connection X and Y in the circuit diagram

6.6 Brake Pressure Shut Off (BPS)

Pressure regulating motors shift towards maximum displacement if the operating pressures are equal to or above the regulation begin (RB) pressure setting, irrespective of which working port the pressure is generated. With propel systems, this can lead to unpleasant effects if, for example, during dynamic braking high pressures are generated above the regulation begin setting, the motor will shift to

maximum displacement and an extremely strong braking effect will occur.

Brake pressure shutoff prevents the braking pressure or deceleration pressure from reaching the regulator. Only the drive pressure or acceleration pressure is felt by the motor's pressure regulator, and thus the motor will remain in minimum displacement during braking.

Suitability and availability for motor types		Fixed displ. motor		Variable displ. motor		Var. displ. motor + override control	Pressure regulating motor	
	Circuit diagram	open	closed	open	closed	closed	open	closed
Without brake pressure shut off		✓	✓	✓	✓	-	✓	-
With brake pressure shut off		-	-	-	-	✓	-	✓

6.7 Counter Balance

The counter balance valve prevents over speeding the motor during an over running condition. To achieve this, the motor's exhaust oil is automatically metered to restrict its escape. With integrated anti-cavitation circuitry, cavitation can be prevented.

In addition, a flushing valve can be incorporated to allow motor case flushing.

Counter balance valves are typically used in drive systems in open loop circuits.

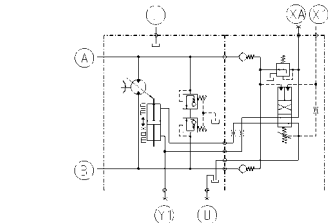
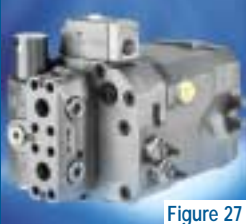
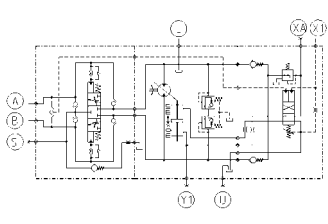

Suitability and availability for motor types			Fixed displacement motor		Variable displacement motor		Variable displ. motor + override control	Pressure regulating motor	
	Photo	Circuit diagram	open	closed	open	closed	closed	open	closed
Without counter-balance	 Figure 26		✓	✓	✓	✓	✓	✓	✓
With counter-balance valve *1)	 Figure 27		✓	-	-	-	-	✓	-

*1) the rear mount is shown; side mount is also possible.

6.8 Speed Sensor

Motors can be equipped with speed sensors. Please consult factory as not all models and sizes are currently adapted for this option. Speed sensors

detect the motor speed electronically and supply it to an electronic control device in the form of an input signal.

Suitability and availability for motor types			Fixed displ. motor		Variable displ. motor		Var. displ. motor + override control	Pressure regulating motor	
	Photo	Circuit loop	open	closed	open	closed	closed	open	closed
Without speed sensor	 Figure 7		✓	✓	✓	✓	✓	✓	✓
With speed sensor *1)	 Figure 8		✓	✓	✓	✓	-	✓	✓

*1) Illustration is one example, other versions are available. Please consult factory for availability and technical data.

Model Codes for H-Series-02 Fixed Displacement Motors

MODEL
HMF
 H-Series
 Fixed Motor
EXAMPLE:

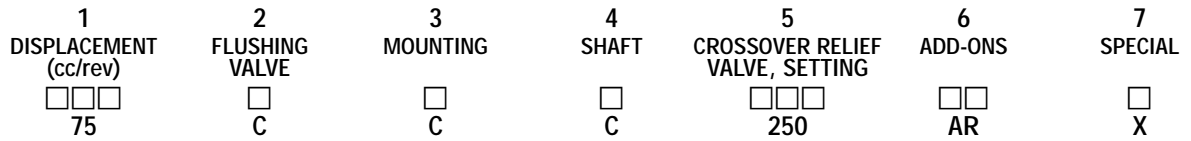

1 DISPLACEMENT SIZE

28 (1.71 cir)
 35 (2.12 cir)
 50 (3.05 cir)
 75 (4.57 cir)
 105 (6.40 cir)
 135 (8.24 cir)

2 FLUSHING

C = CLOSED LOOP
 O = OPEN LOOP
 P = PLAIN
 B = BLOCKED
 Note: With integrated COR's
 motors are P.

3 MOUNTING

B = SAE B 2 BOLT (28,35)
 C = SAE C 2 BOLT (50, 75, 105)
 D = SAE D 2 BOLT (135)

7 SPECIALS (2)

INSERT S, THEN CALL OUT
 REQUIREMENT IN CLEAR TEXT

6 ADD-ONS

Port Orientation
 A = SIDE PORTS
 B = REAR PORTS (4)

Additional Valves:
 C = CBV
 R = COR
 V = DUAL PRESSURE R/V'S (3)

5 COR VALVE SETTING (3)

CALL OUT SETTING IN BAR
 1 BAR = 14.5 PSI

6 SHAFT

J = SAE BB (35)
 C = SAE C (50, 75)
 H = ANSI 16.32, 21T (50,75)
 23T (105)
 27T (135)
 D = SAE D 13T (135)

- NOTES:** (1) If codes are **not** used, insert the letter "X"
 (2) If a unit is a **special execution**, insert "S" at the end of the code description
 (3) Specify lower setting in bar in position 5, then call out in clear text higher setting.
 (4) Side ports are standard. End ports are not normally available. Consult factory.

Model Codes for H-Series-02 Regulated Motors

MODEL	1 DISPLACEMENT (cc/rev)	2 FLUSHING VALVE	3 CONTROL	4 CONTROL OPTIONS	5 MOUNTING	6 SHAFT	7 RB	8 DISP. MAXIMUM	9 DISP. MINIMUM	10 ADD-ONS	11 SPECIALS
HMR	<input type="checkbox"/> <input type="checkbox"/> <input type="checkbox"/>	<input type="checkbox"/>	<input type="checkbox"/>	<input type="checkbox"/>	<input type="checkbox"/> <input type="checkbox"/> <input type="checkbox"/>	<input type="checkbox"/> <input type="checkbox"/>	<input type="checkbox"/> <input type="checkbox"/> <input type="checkbox"/>	<input type="checkbox"/> <input type="checkbox"/> <input type="checkbox"/>	<input type="checkbox"/> <input type="checkbox"/>	<input type="checkbox"/> <input type="checkbox"/> <input type="checkbox"/>	<input type="checkbox"/>
EXAMPLE:	135	P	R	B	D	H	260	X	41	BRN	S

1 DISPLACEMENT (CC/REV)
 75 (4.63 cir)
 105 (6.41 cir)
 135 (8.27 cir)

2 FLUSHING
 C = CLOSED LOOP
 O = OPEN LOOP
 P = PLAIN
 B = BLOCKED
 Note: With integral COR's motors are P.

3 CONTROL
 R = SYSTEM PRESSURE REGULATED (STD)
 2 = REGULATOR SET UP FOR TWO POSITION CONTROL (default is max; shift to min.)
 Z = REGULATOR SET UP FOR TWO POSITION CONTROL (default is min; shift to max.)

4 CONTROL OPTIONS
 B = BI-DIRECTIONAL REGULATOR SHUTTLE (STD)
 U = UNI-DIRECTIONAL (3)
 N = NONE (Ext. fed to regulator)

5 MOUNTING
 C = SAE C 2 BOLT MTG (75, 105)
 D = SAE D 2 BOLT MTG (135)
 S = SPECIAL PLUG IN MOUNT (105, 135)

6 SHAFT
 H = ANSI 21T 16/32 P (75)
 23T 16/32 P (105)
 27T 16/32 P (135)
 C = SAE C 14T 12/24 P (OPT 75, 105)
 D = SAE E 13T 8/16 P (OPT 75, 105)

7 REGULATION BEGIN
 SPECIFY SETTING IN BAR
 1 BAR = 14.5 PSI

11 SPECIALS (2)
 INSERT S, THEN CALL OUT REQUIREMENT IN CLEAR TEXT

10 ADD-ONS
 Port Orientation
 A = SIDE PORTS
 B = REAR PORTS (4)
 Additional Valves:
 A = BRAKE CBV ON "A" PORT
 B = BRAKE CBV ON "B" PORT
 C = CLOSED CENTER CBV (1)
 O = ORIFICED CENTER CBV (1)
 R = COR (NO CBV) (1)
 X = NONE
 Dor Options:
 D = PILOT PRESS DOR
 H = SYSTEM PRESS DOR
 E = ELECT DOR w/BPS (2)
 F = ELECT DOR w/o BPS (2)
 N = PNEUM. DOR
 X = NONE
NOTE: Check with factory for availability of add-on options for desired unit size.

9 MIN. DISPLACEMENT
 SPECIFY SETTING IN CC/REV
 22 = MIN. DISPL. FOR 75
 31 = MIN. DISPL. FOR 105
 41 = MIN. DISPL. FOR 135

8 MAX. DISPLACEMENT
 IF NOT DESTROYED, ENTER X. OTHERWISE, SPECIFY SETTING IN CC/REV.

NOTES: (1) If motor has COR _____, enter "S" in column 1 and specify relief valve setting in bar.
 (2) Enter "S" in column 11 and specify either 12 or 24 VDC solenoids. Reference: BPS = Brake Pressure Shut-off.
 (3) Enter "S" in column 11 and specify which pressure port should feed regulator. (A or B, see installation drawings).

Model Codes for H-Series-02 Variable Motors

MODEL	1 DISPLACEMENT (cc/rev)	2 FLUSHING VALVE	3 CONTROL	4 CONTROL OPTIONS	5 MOUNTING	6 SHAFT	7 R/V SETTING	8 DISP. MAXIMUM	9 DISP. MINIMUM	10 ADD-ONS	11 SPECIALS
EXAMPLE:	□□□ 135	□ K	□ T	□	□□□ D	□□ H	□□□ X	□□□ X	□□ 41	□□□ BXE	□ S

1 DISPLACEMENT (CC/REV)

55 (3.36 cir)
75 (4.63 cir)
105 (6.41 cir)
135 (8.27 cir)

2 FLUSHING

C = CLOSED LOOP
K = 14 BAR CLOSED LOOP (1)
O = OPEN LOOP
B = BLOCKED
P = PLAIN
Note: With integral COR's
motors are P.

3 CONTROL

T = HYD. INFINITELY VARIABLE
E = ELECT INFINITELY VARIABLE
2 = TWO POSITION
1 = SINGLE LINE
TWO POSITION (4)
F = ELECT TWO POSITION
L = SINGLE LINE ELECT
TWO POSITION (4)

4 CONTROL OPTIONS

1 = 12 VDC
2 = 24 VDC
Option is only applicable if
control is "E", "F" or "L"
D = pilot to shift
H = System press to shift
Option is only applicable if
control is "1".

5 MOUNTING

C = SAE C 2 BOLT MTG
(55, 75, 105)
D = SAE D 2 BOLT MTG (135)
S = SPECIAL PLUG IN MOUNT
(105, 135)

6 SHAFT

H = ANSI 21T 16/32 P (75)
23T 16/32 P (105)
27T 16/32 P (135)
C = SAE C 14T 12/24 P (55)
(OPT 75, 105)
D = SAE E 13T 8/16 P
(OPT 75, 105)

11 SPECIALS (2)

INSERT S, THEN CALL OUT
REQUIREMENT IN CLEAR TEXT

10 ADD-ONS

Port Orientation
A = SIDE PORTS
B = REAR PORTS (4)
Additional Valves:
C = CLOSED CENTER CBV (2)
O = ORIFICED CENTER CBV (2)
R = COR (NO CBV) (2)
X = NONE
Additional Control Options:
Y = F PORT ACTIVE
X = NONE
P = POR w/o DOR (3)
D = POR w/ PILOT PRESS DOR (3)
H = POR w/ SYSTEM PRESS DOR (3)
E = POR w/ ELECT DOR w/BPS (3)
F = POR w/ ELECT DOR w/o BPS (3)
N = POR w/ PNEUM. DOR (3)
NOTE: Check with factory for
availability of add-on options
for desired unit size.

9 MIN. DISPLACEMENT

SPECIFY SETTING IN CC/REV
18 = MIN. DISPL. FOR 55
22 = MIN. DISPL. FOR 75
31 = MIN. DISPL. FOR 105
41 = MIN. DISPL. FOR 135

8 MAX. DISPLACEMENT

IF NOT DESTROKED, ENTER X.
OTHERWISE, SPECIFY SETTING
IN CC/REV.

7 RELIEF SETTING

IF NO COR, ENTER "X"
OTHERWISE, SPECIFY SETTING
IN BAR. (1 BAR = 14.5 PSI)

- NOTES:** (1) Standard for HMV 55, 75, 105 and 135 with "T" control with factory POR option.
(2) If motor has COR, specify setting in bar in column 7.
(3) These are factory POR options and only available on HMV 75, 105 and 135 with "T" control. Enter "S" in column 11 and specify POR setting in bar. For POR options "E" or "F", include specification or 12 or 24 VDC solenoids. Reference: BPS = Brake Pressure Shut-off.
(4) Single line two position motors are special executions. Options are limited based on standard configuration available from production. Please consult factory.

8. GENERAL DIMENSIONS

8.1 HMF-02 Fixed Displacement Motors (SAE Flange Version)

Side Ports	Rear Ports	Rated Sizes	28	35	50	75	105	135	165	210	
			2-Bolt mount								
		Flange profile	SAE B		SAE C			SAE D			
			ANSI B92.1; 16/32 spline pitch								
		Shaft profile									
		Number of teeth	15		21		23		27		
		D1 [mm]	101,6		127		156,4		156,4		
		B1 [mm]	146		181		228,6		228,6		
		B2 [mm]	162		200		250		250		
		B3 [mm]	146			166					
		B4 [mm]	149			169					
		H1 [mm]	61		70		73		82		
		H2 [mm]	61		70		73		82		
		H3 [mm]	67		72		78		83		
		w/o crossover relief valves	108		116		119		128		
			129		137		140		149		
		w/ crossover relief valves	69		79		83		88		
		H4 [mm]	64		69		75		80		
		H5 [mm]	41		56		75		75		
		L1 [mm]	193		202		229		254		
		L2 [mm]	191		200		227		252		
		L3 [mm]									
		L, U	M22x1,5								
		E *1)	M18x1,5			M22x1,5					

*1) Connection for anti-cavitation oil supply

Under development

8.2 HMV-02 Variable Displacement Motors (SAE Flange Version)

Side Ports	Rear Ports	Rated Sizes	35	55	75	105	135	165	210		
			2-Bolt mount								
		Flange profile	SAE C		SAE D						
			ANSI B92.1; 16/32 spline pitch								
		Shaft profile									
		Number of teeth	21		23		27				
		D1 [mm]	127		156,4		156,4				
		B1 [mm]	181		228,6		228,6				
		B2 [mm]	208		258		258				
		B3 [mm]	86		96		108		108		
		B4 [mm]	85		95		96		108		
		B5 [mm]	86		95		96		108		
		B6 [mm]	85		95		96		108		
		B7 [mm]	-		180		181		193		
		B8 [mm]	-		180		181		193		
		H1 [mm]	80		86		91		96		
		H2 [mm]	83		93		99		103		
		H3 [mm]	84		93		95		108		
		H4 [mm]	90		105		106		114		
		H5 [mm]	84		93		96		107		
		H6 [mm]	90		105		105		114		
		H7 [mm]	-		88		88				
		H8 [mm]	-		92		92				
		L1 [mm]	41		56		75		75		
		L2 [mm]	212		226		247		270		
		L3 [mm]	hydraulic control		23		23				
			electric control		75		75				
		L4 [mm]	217		231		252		275		
		L5 [mm]	hydraulic control		18		18				
			electric control		70		70				
		L6 [mm]	-		33		33				
		L7 [mm]	-		28		28				
		L8 [mm]	-		80		80				
		L, U	M22x1,5			M26x1,5					
		E *1)	M14x1,5			M14x1,5					
		X *2)	M14x1,5			M14x1,5					
		M, M1 *3)	Specification: s. S. 5								
		M2 *4)	Specification: s. S. 5								

*1) Connection for external servo supply pressure feed

*2) Connection for hydraulic control

*3) Solenoid for electric control

*4) Solenoid for brake pressure shut off

All metric threaded connections per DIN 3852
Threaded connections per ISO 6149 on request.

Please consult factory for dimensions
of the versions with speed sensors.

8.3. HMR-02 Pressure Regulating Motors (SAE Flange Version)

Side Ports		Rear Ports		Rated Sizes		35	55	75	105	135	165	210	
				Flange profile		2-Bolt mount							
				SAE		SAE C		SAE D					
with Counter Balance Valve				Shaft profile		ANSI B92.1; 16/32 spline pitch							
				Number of teeth		21		23		27			
				D1 [mm]		127		156,4					
				B1 [mm]		181		228,6					
				B2 [mm]		208		258					
				B3 [mm]		without/with secondary relief valve		95		99		108	
				B4 [mm]		without/with secondary relief valve		135		136		140	
				B5 [mm]		without/with secondary relief valve		95		105		108	
				B6 [mm]		without/with secondary relief valve		102		105		114	
				B7 [mm]		pneumatic		95		99		108	
						hydraulic		135		139		141	
				B8 [mm]				102		105		114	
				B9 [mm]				74					
				B10 [mm]				62					
				B11 [mm]				78					
				H1 [mm]				103					
				H2 [mm]				89					
				H3 [mm]				130					
				H4 [mm]				86		91		96	
				H5 [mm]				93		99		100	
				H6 [mm]				93		98		108	
				H7 [mm]				102		102		110	
				H8 [mm]				56					
				H9 [mm]				91		96		107	
				L1 [mm]				102		102		109	
				L2 [mm]				81					
				L3 [mm]				85					
				L4 [mm]				56		75			
				L5 [mm] *4)				229		247		270	
				L6 [mm]				231		252		275	
				L, U				53					
				X1 *1)				80					
				M1 *2)				127					
				M2 *3)				M22x1,5					
								M14x1,5					
								Specification: see pg. 5					
								Specification: see pg. 5					

*1) Connection for hydraulic or pneumatic maximum displacement override
 *2) Solenoid magnet for electric maximum displacement override

*3) Solenoid magnet for brake pressure shut off
 *4) Regulator with electric maximum displacement override and brake pressure shut off

8.4. Plug-in Motors

Variable displacement motor *1)		Rated sizes		35	55	75	105	135	165	210	
		D1 [mm]		Under development		190		216			
		D2 [mm]				251		282			
		F1 [mm]				- *2)		55,8			
		F2 [mm]				0 *2)		223,4			
		F3 [mm]				- *2)		129			
		F4 [mm]				224 *2)		251,8			
		L1 [mm]				143		169			
		L2 [mm]				124		132		175	

*1) Some of the dimensions in Sections 8.1 through 8.3 may be applicable

*2) Size 75 has a 2-bolt SAE flange.

8.5. High-Pressure Connections

		Rated sizes		28	35	55	75	105	135	165	210
		F1 [mm]		50,8		57,2					
		F2 [mm]		74		84					
		F3 [mm]		23,8		27,8					
		A, B		3/4"		1"					
		S *1)		M10		M12					

*1) 17 mm deep, 8 places

All metric threaded connections per DIN 3852.
 Threaded connections per ISO 6149 on request.

Please consult factory for dimensions of the versions with speed sensors.

9. SPECIAL MOTORS

Along with the motor versions shown in Sections 2 through 4, Linde also offers custom solutions for special requirements. If you don't see a solution that

fits your requirements, please check with our application specialists.

9.1 Fixed Displacement Motor with Integrated Controls

This motor offers an integrated

- Directional control valve
- Torque control
- Priority function
- Crossover relief valve protection with anti-cavitation function

- Case flushing function
- Dual pressure relief valves ideal for use in turning and boring mill drives and swing drives in an open loop circuit.

Note: Must be used with a load sensing (LS) pump.

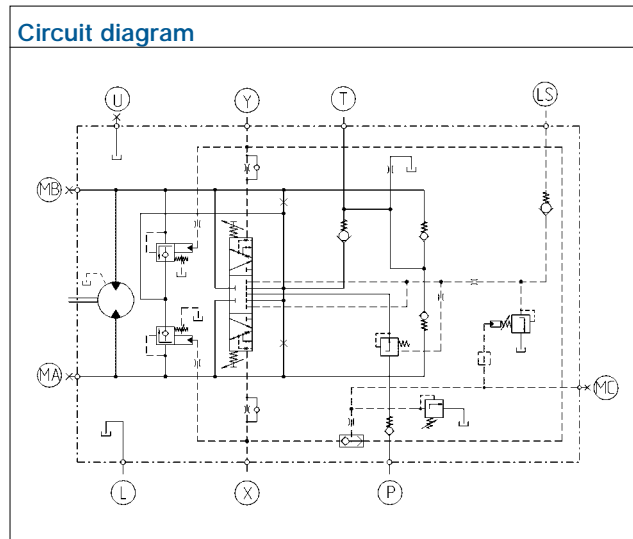

P, T Work port connections
L, U Case drain/vent connections

LS LS pressure connection
MA, MB, MC Gauge ports

9.2 Double Motor

With:

- Two rotating groups coupled together
- A large range of displacement

- This motor offers an ideal solution for applications that need to have high starting torque but also require high speed



Double motor in isometric view



Double motor in side view

10. PRESSURE FLUIDS AND FILTRATION

Permissible Pressure Fluids

- HLP mineral oil per DIN 51524
- Biodegradable oils on request
- Other pressure media on request

Technical Data

Pressure fluid temperature range	[°C]	-20 to +90
Operating viscosity range	[mm ² /s] = [cSt]	10 to 80
Optimum operating viscosity range	[mm ² /s] = [cSt]	15 to 30
Maximum viscosity (temporary, during startup)	[mm ² /s] = [cSt]	1000

Viscosity Recommendations

Operating temperature [°C]	Viscosity class [mm ² /s] = [cSt] at 40°
Approx. 30 to 40	22
Approx. 60 to 80	46 or 68

Linde recommends using only pressure fluids which are confirmed by the producer as suitable for use in high pressure hydraulic installations. For the correct choice of suitable pressure fluid it is necessary to know the working temperature in the hydraulic circuit (closed loop). The pressure fluid chosen must allow the working viscosity to be within the optimum viscosity range (refer to above table).

Attention:

Due to pressure and speed influences, the leakage fluid temperature is always higher than the circuit temperature. The temperature must not exceed 90°C in any part of the system. Under special circumstances, if the stated conditions cannot be observed, then please consult Linde.

Filtration

In order to guarantee functions and efficiency of the hydraulic motors the purity of the pressure fluid over the entire operating period, must comply to at least class 18/13 according to ISO 4406.

With modern filtration technology, however, much better values can be achieved which contributes significantly to extending the life and durability of the hydraulic motors and complete system.

11. AREAS OF APPLICATION





Linde Hydraulics Corporation

P.O. Box 82 • 5089 Western Reserve Road • Canfield, Ohio 44406-0082

Telephone (330) 533-6801 • Fax (330) 533-6893

Email info@lindeamerica.com • Internet <http://www.lindeamerica.com>